

Data Sheet

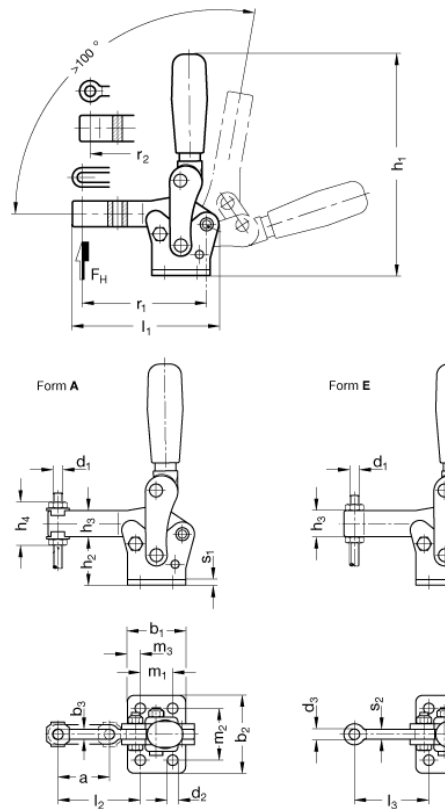

Article number: 201343104
 Description: E+G vertical clamp
 GN 910-220-E

Measures



a	= 32	h1	= 136.5	m1	= 20
b1	= 36	h2	= 30	m2	= 32
b2	= 48	h3	= 16	m3	= 8
b3	= 6.5	h4	= 27	r1	= 77
d1	= M 6	Holding force N	= 2200	r2	= 72
d2	= 6.5	l1	= 91	s1	= 4
d3	= 6.5	l2	= 51	s2	= 6
Form E	= 86	l3	= 46	Size	= 220